

### Self-Capacitive Touch Panel Controller

#### INTRODUCTION

The FT6336U are single-chip capacitive touch panel controller IC with a built-in 16 bit enhanced Micro-controller unit (MCU). They adopt the self-capacitance technology, which supports single point and gesture touch or two points. In conjunction with a self-capacitive touch panel, The FT6336U implement the user-friendly input function and are widely used in various portable devices, such as smart phones, MIDs and GPS.

#### FEATURES

- Self-Capacitive Sensing Techniques support single point touch and gesture or two point touch
- Absolute X and Y coordinates or gesture
- 1 point and gestures / 2 points supported
- High immunity to RF and power Interferences
- Auto-calibration: Insensitive to Capacitance and Environmental Variations
- Built-in Enhanced MCU
- FT6336U supports up to 39 channels of sensors /drivers
- Report Rate: Up to 100Hz
- Support Interfaces :I2C
- Support single film material TP and triangle pattern without additional shield
- Internal accuracy ADC and smooth filters
- Support 2.8V to 3.6V Operating Voltage
- Support independent IOVCC
- Built-in LDO for Digital Circuits
- High efficient power management with 3 Operating Modes
  - Active Mode
  - Monitor Mode
  - Hibernation Mode
- Operating Temperature Range: -40°C to +85°C
- ESD:HBM≥7500V, MM≥500V

## TABLE OF CONTENTS

INTRODUCTION.....	I
FEATURES.....	I
<b>1 OVERVIEW .....</b>	<b>1</b>
1.1 TYPICAL APPLICATIONS .....	1
<b>2 FUNCTIONAL DESCRIPTION.....</b>	<b>1</b>
2.1 ARCHITECTURAL OVERVIEW.....	1
2.2 MCU.....	2
2.3 OPERATION MODES.....	2
2.4 SERIAL INTERFACE.....	3
2.4.1 I2C.....	3
<b>3 ELECTRICAL SPECIFICATIONS.....</b>	<b>4</b>
3.1 ABSOLUTE MAXIMUM RATINGS.....	4
3.2 DC CHARACTERISTICS .....	4
3.3 AC CHARACTERISTICS .....	5
3.4 I/O PORTS CIRCUITS.....	6
3.5 POWER ON/RESET/WAKE SEQUENCE.....	6
<b>4 PIN CONFIGURATIONS .....</b>	<b>8</b>
<b>5 PACKAGE INFORMATION .....</b>	<b>10</b>
5.1 PACKAGE INFORMATION OF QFN-5X5-48L PACKAGE .....	10

# 1 OVERVIEW

## 1.1 Typical Applications

FT6336U accommodate a wide range of applications with a set of buttons up to a 2D touch sensing device, their typical applications are listed below.

- Mobile phones, smart phones
- GPS
- Game consoles
- POS (Point of Sales) devices
- Portable MP3 and MP4 media players
- Digital cameras
- MIDs

FT6336U series ICs support up to 5 inch Touch Panel; users may find out their target IC from the specs listed in the following table,

Model Name	Panel	Package			Touch Panel Size
	Channel	Type	Pin	Size	
FT6336U	39	QFN5*5	48	0.6-P0.35	≤5.0 inch

# 2 FUNCTIONAL DESCRIPTION

## 2.1 Architectural Overview

Figure2-1 shows the overall architecture for the FT6336U.

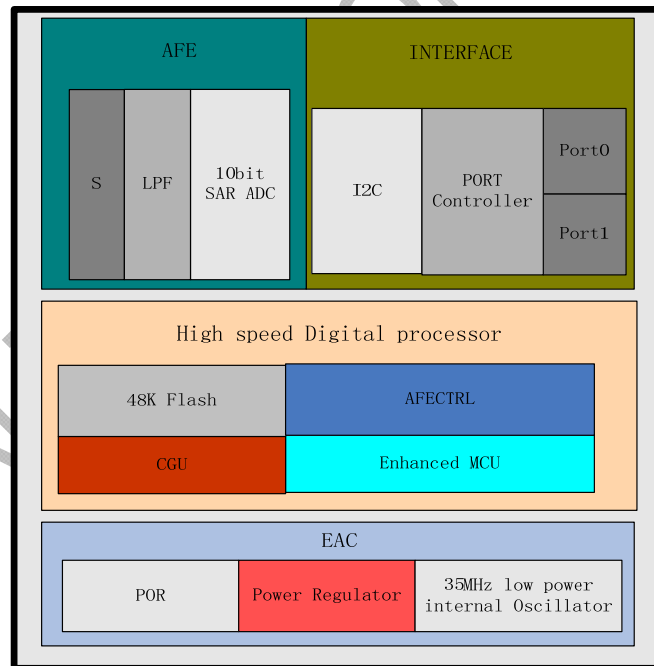

Figure 2-1 FT6336U System Architecture Diagram

The FT6336U is comprised of five main functional parts listed below,

- Touch Panel Interface Circuits

The main function for the AFE and AFE controller is to interface with the touch panel. It scans the panel by sending AC signals to the panel and processes the received signals from the panel. So it supports both driver and Sensor functions. Key parameters to configure this circuit can be sent via serial interfaces.

- Enhanced MCU

For the Enhanced MCU, larger program and data memories are supported. Furthermore, A Flash ROM is implemented to store

programs and some key parameters.

Complex signal processing algorithms are implemented by MCU to detect the touches reliably and efficiently.

Communication protocol software is also implemented on this MCU to exchange data and control information with the host processor.

- External Interface
  - I2C: an interface for data exchange with host
  - INT: an interrupt signal to inform the host processor that touch data is ready for read
  - RSTN: an external low signal reset the chip.
- A watch dog timer is implemented to ensure the robustness of the chip.
- A voltage regulator to generate 1.5V for digital circuits from the input VDDA supply.

## 2.2 MCU

This section describes some critical features and operations supported by the Enhanced MCU.

Figure 2-2 shows the overall structure of the MCU block. In addition to the Enhanced MCU core, we have added the following circuits,

- Memory: 48KB Flash
- Data Memory: 5KB SRAM
- Timer: A number of timers are available to generate different clocks
- Master Clock: 18MHz from a 36MHz RC Oscillator
- Clock Manager: To control various clocks under different operation conditions of the system

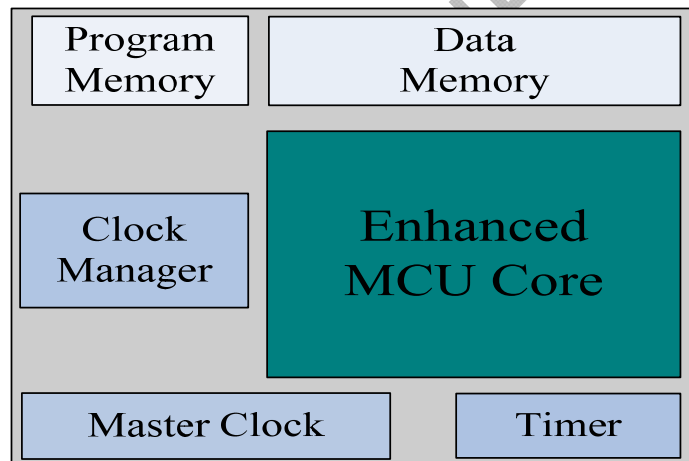

Figure 2-2 MCU Block Diagram

## 2.3 Operation Modes

FT6336U operates in the following three modes:

- Active Mode

In this mode, FT6336U actively scans the panel. The default scan rate is 60 frames per second. The host processor can configure FT6336U to speed up or to slow down.

- Monitor Mode

In this mode, FT6336U scans the panel at a reduced speed. The default scan rate is 25 frames per second and the host processor can increase or decrease this rate. When in this mode, most algorithms are stopped. A simpler algorithm is being executed to determine if there is a touch or not. When a touch is detected, FT6336U shall enter the Active mode immediately to acquire the touch information quickly. During this mode, the serial port is closed and no data shall be transferred with the host processor

- Hibernation Mode

In this mode, the chip is set in a power down mode. It shall respond to the “RESET” or “Wakeup” signal from the host processor. The chip therefore consumes very little current, which help prolong the standby time for the portable devices.

**Host Interface** Figure 2-3 shows the interface between a host processor and FT6336U. This interface consists of the following three sets of signals:

- Serial Interface

- Interrupt from FT6336U to the Host
- Reset Signal from the Host to FT6336U

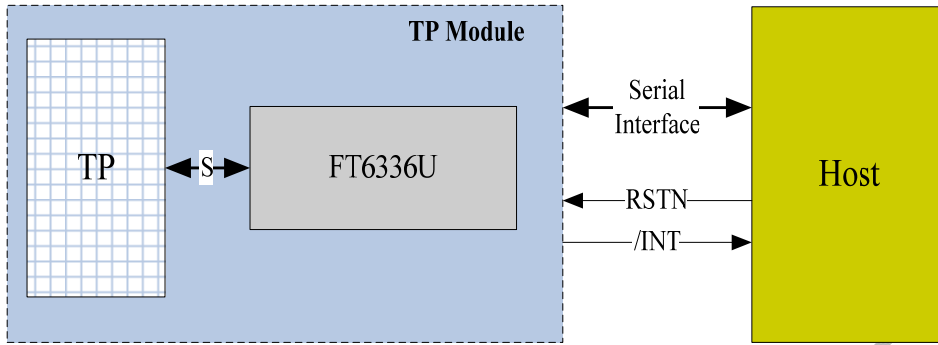

Figure 2-3 Host Interface Diagram

The serial interface of FT6336U is I2C. The details of this interface are described in detail in Section 2.4. The interrupt signal (/INT) is used for FT6336U to inform the host that data are ready for the host to receive. The RSTN signal is used for the host to reset FT6336U. After resetting, FT6336U shall enter the Active mode.

## 2.4 Serial Interface

FT6336U supports the I2C interfaces, which can be used by a host processor or other devices.

### 2.4.1 I2C

The I2C is always configured in the Slave mode. The data transfer format is shown in [Figure 2-4](#).

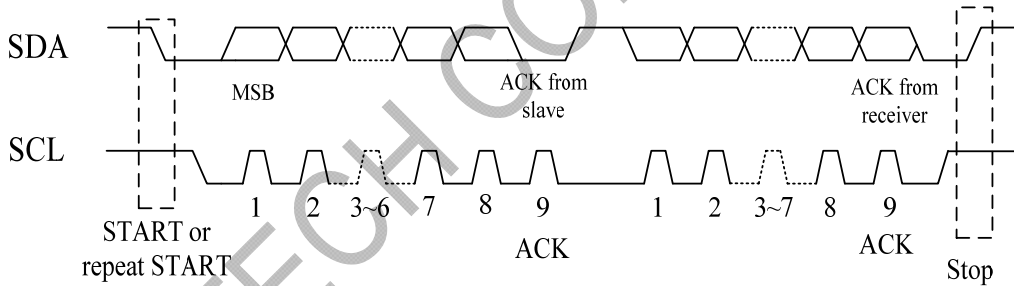

Figure 2-4 I2C Serial Data Transfer Format

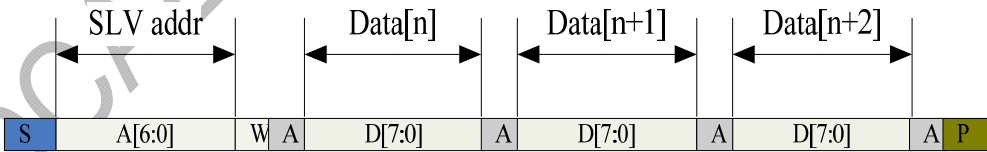

Figure 2-5 I2C master write, slave read

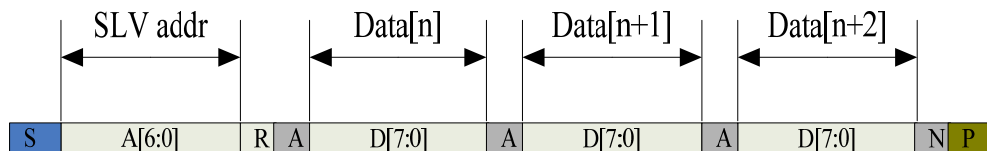

Figure 2-6 I2C master read, slave write

Table 2-1 lists the meanings of the mnemonics used in the above figures.

**Table 2-1 Mnemonics Description**

THIS DOCUMENT CONTAINS INFORMATION PROPRIETARY TO FOCALTECH SYSTEMS CO.,LTD., AND MAY NOT BE REPRODUCED, DISCLOSED OR USED IN WHOLE OR PART WITHOUT THE EXPRESS WRITTEN PERMISSION OF FOCALTECH SYSTEMS CO.,LTD.

Mnemonics	Description
S	I2C Start or I2C Restart
A[6:0]	Slave address
R/W	READ/WRITE bit, '1' for read, '0' for write
A(N)	ACK(NACK)
P	STOP: the indication of the end of a packet (if this bit is missing, S will indicate the end of the current packet and the beginning of the next packet)

I2C Interface Timing Characteristics is shown in Table 2-2.

**Table 2-2 I2C Timing Characteristics**

Parameter	Min	Max	Unit
SCL frequency	10	400	KHz
Bus free time between a STOP and START condition	4.7	\	us
Hold time (repeated) START condition	4.0	\	us
Data setup time	250	\	ns
Setup time for a repeated START condition	4.7	\	us
Setup Time for STOP condition	4.0	\	us

### 3 ELECTRICAL SPECIFICATIONS

#### 3.1 Absolute Maximum Ratings

**Table 3-1 Absolute Maximum Ratings**

Item	Symbol	Value	Unit	Note
Power Supply Voltage	VDDA - VSSA	-0.3 ~ +3.6	V	1, 2
Power Supply Voltage2	VDD3 - VSS	-0.3 ~ +3.6	V	1, 3
I/O Digital Voltage	IOVCC	1.8~3.6	V	1
Operating Temperature	Topr	-40 ~ +85	°C	1
Storage Temperature	Tstg	-55 ~ +150	°C	1

#### Notes

1. If used beyond the absolute maximum ratings, FT6336U may be permanently damaged. It is strongly recommended that the device be used within the electrical characteristics in normal operations. If exposed to the condition not within the electrical characteristics, it may affect the reliability of the device.
2. Make sure VDDA (high)  $\geq$  VSSA (low).
3. Make sure VDD3(high)  $\geq$  VSS(low).

#### 3.2 DC Characteristics

**Table 3-2 DC Characteristics (VDDA=2.8~3.6V, Ta=-40~85°C)**

Item	Symbol	Test Condition	Min.	Typ.	Max.	Unit	Note
Input high-level voltage	VIH		0.7 x IOVCC	-	IOVCC	V	
Input low -level voltage	VIL		-0.3	-	0.3 x IOVCC	V	
Output high -level voltage	VOH	IOH=-0.1mA	0.7 x IOVCC	-	-	V	
Output low -level voltage	VOL	IOH=0.1mA	-	-	0.3 x IOVCC	V	
I/O leakage current	ILI	Vin=0~VDDA	-1	-	1	μA	

THIS DOCUMENT CONTAINS INFORMATION PROPRIETARY TO FOCALTECH SYSTEMS CO.,LTD., AND MAY NOT BE REPRODUCED, DISCLOSED OR USED IN WHOLE OR PART WITHOUT THE EXPRESS WRITTEN PERMISSION OF FOCALTECH SYSTEMS CO.,LTD.

Current consumption (Normal operation mode)	Iopr	VDDA =VDD3= 2.8V Ta=25°C MCLK=18MHz	-	4.32 <sup>*1</sup>	-	mA	
Current consumption (Monitor mode)	Imon	VDDA =VDD3= 2.8V Ta=25°C MCLK=18MHz	-	220 <sup>*2</sup>	-	uA	
Current consumption (Sleep mode)	Islp	VDDA =VDD3= 2.8V Ta=25°C	-	55	-	uA	
Step-up output voltage	VDD5	VDDA = VDD3=2.8V	-	5	-	V	
Power Supply voltage	VDDA VDD3		2.8	-	3.3	V	

\*1: Report Rate: 75Hz @ 4<sup>th</sup>TP

\*2: Report Rate: 25Hz @ 4<sup>th</sup>TP

### 3.3 AC Characteristics

**Table 3-3 AC Characteristics of Oscillators**

Item	Symbol	Test Condition	Min	Typ.	Max	Unit	Note
OSC clock 1	fosc1	VDDA= 2.8V; Ta=25°C	34.64	36	36.36	MHz	

**Table 3-4 AC Characteristics of sensor**

Item	Symbol	Test Condition	Min	Typ.	Max	Unit	Note
Sensor acceptable clock	ftx	VDDA= 2.8V; Ta=25°C	0	100	300	KHz	
Sensor output rise time	Ttxr	VDDA= 2.8V; Ta=25°C	-	100	-	nS	
Sensor output fall time	Ttxf	VDDA= 2.8V; Ta=25°C	-	80	-	nS	
Sensor input voltage	Trxi	VDDA= 2.8V; Ta=25°C	-	5	-	V	

### 3.4 I/O Ports Circuits

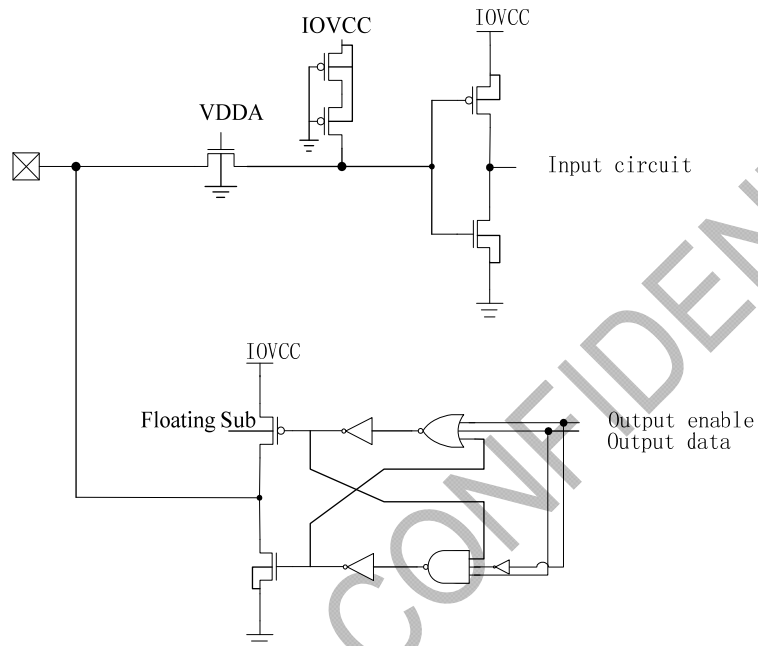

Figure 3-1 Digital In/Out Port Circuit

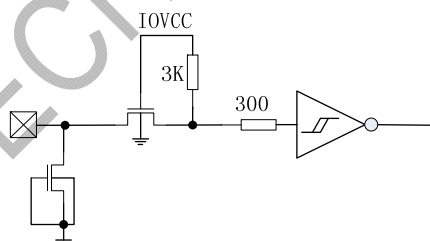

Figure 3-2 Reset Input Port Circuits

### 3.5 POWER ON/Reset/Wake Sequence

The GPIO such as INT and I2C are advised to be low before powering on. Reset should be pulled down to be low before powering on. INT signal will be sent to the host after initializing all parameters and then start to report points to the host. If Power is down, the voltage of supply must be below 0.3V and Trst is more than 5ms.

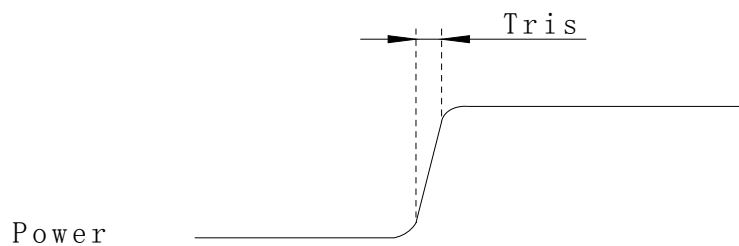



Figure 3-7 Power on time

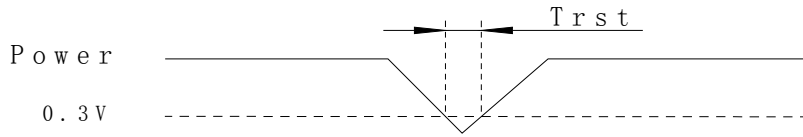

Figure 3-8 Power Cycle requirement

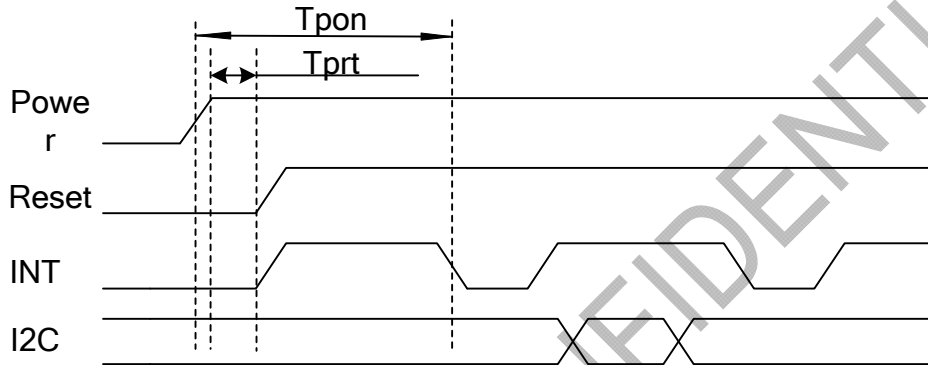

Figure 3-9 Power on Sequence

Reset time must be enough to guarantee reliable reset, the time of starting to report point after resetting approach to the time of starting to report point after powering on.

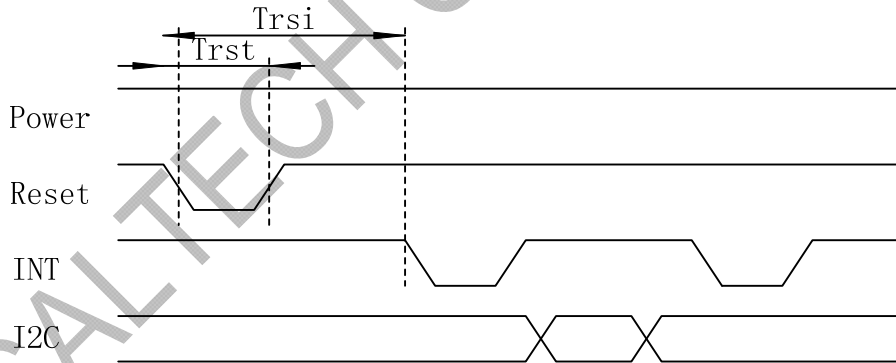

Figure 3-10 Reset Sequence

Table 3-5 Power on/Reset/Wake Sequence Parameters

Parameter	Description	Min	Max	Units
Tris	Rise time from 0.1VDD to 0.9VDD	-	3	ms
Tpon	Time of starting to report point after powering on	300	-	ms
Tprt	Time of being low after powering on	1	-	ms
Trsi	Time of starting to report point after resetting	300	-	ms
Trst	Reset time	5	-	ms

## 4 PIN CONFIGURATIONS

**Table 4-1 Pin Definition of FT6336U**

Name	Pin No.	Type	Description
VREF	46	PWR	Generated internal reference voltage. A 1 $\mu$ F ceramic capacitor to ground is required.
S1	47	I/O	Capacitance sensor /driver channel
S2	48	I/O	Capacitance sensor /driver channel
S3	1	I/O	Capacitance sensor /driver channel
S4	2	I/O	Capacitance sensor /driver channel
S5	3	I/O	Capacitance sensor /driver channel
S6	4	I/O	Capacitance sensor /driver channel
S7	5	I/O	Capacitance sensor /driver channel
S8	6	I/O	Capacitance sensor /driver channel
S9	7	I/O	Capacitance sensor /driver channel
S10	8	I/O	Capacitance sensor /driver channel
S11	9	I/O	Capacitance sensor /driver channel
S12	10	I/O	Capacitance sensor /driver channel
S13	11	I/O	Capacitance sensor /driver channel
S14	12	I/O	Capacitance sensor /driver channel
S15	13	I/O	Capacitance sensor /driver channel
S16	14	I/O	Capacitance sensor /driver channel
S17	15	I/O	Capacitance sensor /driver channel
S18	16	I/O	Capacitance sensor /driver channel
S19	17	I/O	Capacitance sensor /driver channel
S20	18	I/O	Capacitance sensor /driver channel
S21	19	I/O	Capacitance sensor /driver channel
S22	20	I/O	Capacitance sensor /driver channel
S23	21	I/O	Capacitance sensor /driver channel
S24	22	I/O	Capacitance sensor /driver channel
S25	23	I/O	Capacitance sensor /driver channel
S26	24	I/O	Capacitance sensor /driver channel
S27	25	I/O	Capacitance sensor /driver channel
S28	26	I/O	Capacitance sensor /driver channel
S29	27	I/O	Capacitance sensor /driver channel
S30	28	I/O	Capacitance sensor /driver channel
S31	29	I/O	Capacitance sensor /driver channel
S32	30	I/O	Capacitance sensor /driver channel
S33	31	I/O	Capacitance sensor /driver channel
S34	32	I/O	Capacitance sensor /driver channel
S35	33	I/O	Capacitance sensor /driver channel
S36	34	I/O	Capacitance sensor /driver channel
S37	35	I/O	Capacitance sensor /driver channel
S38	36	I/O	Capacitance sensor /driver channel
S39	37	I/O	Capacitance sensor /driver channel
VDD5	38	PWR	High voltage power supply from the

THIS DOCUMENT CONTAINS INFORMATION PROPRIETARY TO FOCALTECH SYSTEMS CO.,LTD., AND MAY NOT BE REPRODUCED, DISCLOSED OR USED IN WHOLE OR PART WITHOUT THE EXPRESS WRITTEN PERMISSION OF FOCALTECH SYSTEMS CO.,LTD.

			charge pump LDO generated internally. A 1μF ceramic to ground is required.
VDDA	39	PWR	Analog power supply, A 1μF ceramic capacitor to ground is required.
VDDD	40	PWR	Digital power supply. A 1μF ceramic capacitor to ground is required.
RSTN	41	I	External Reset, Low is active
IOVCC	42	PWR	I/O power supply
SCL	43	I/O	I2C clock input
SDA	44	I/O	I2C data input and output
INT	45	I/O	External interrupt to the host

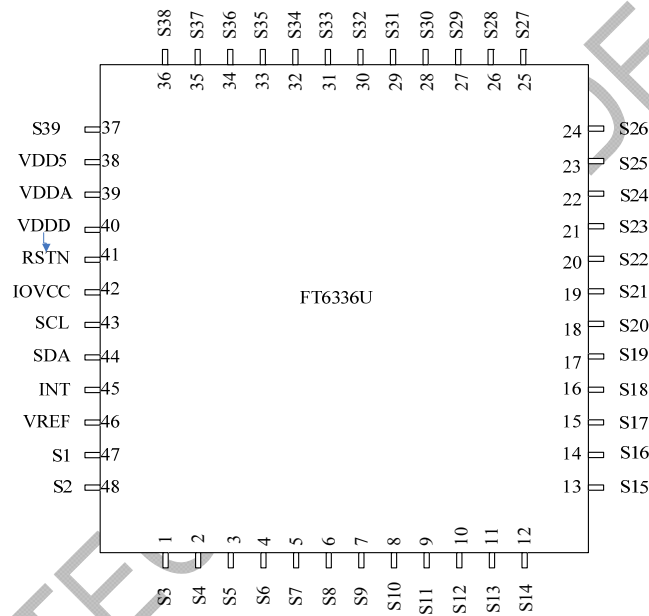

FT6336U Package Diagram

## 5 PACKAGE INFORMATION

### 5.1 Package Information of QFN-5x5-48L Package

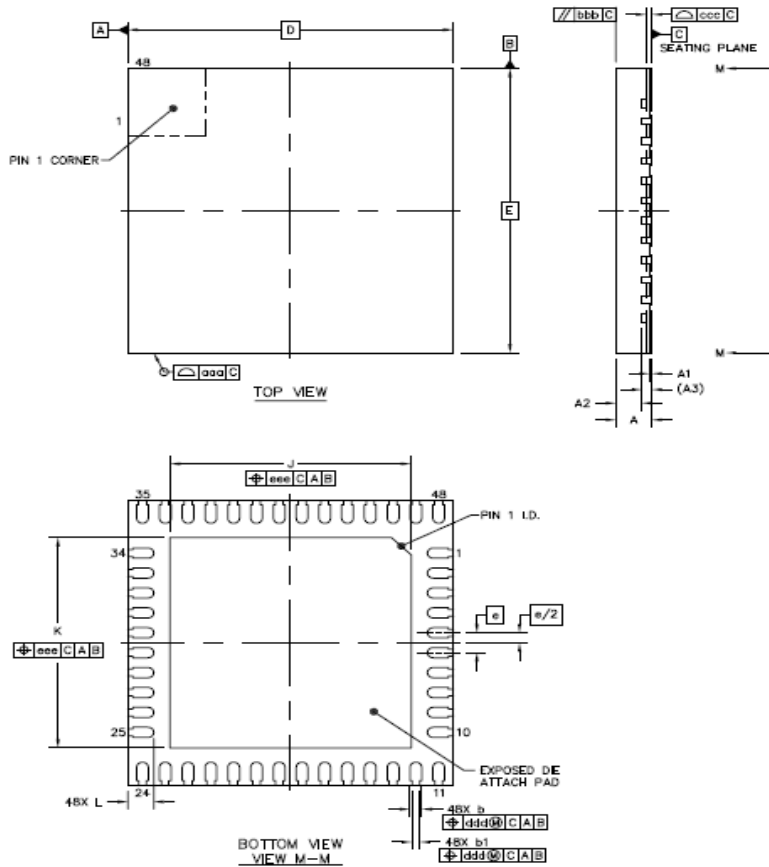

Item	Symbol	Millimeter		
		Min	Type	Max
Total Thickness	A	0.5	0.55	0.6
Stand Off	A1	0	0.035	0.05
Mold Thickness	A2	----	0.4	----
L/F Thickness	A3	0.152 REF		
Lead Width	b	0.13	0.18	0.23
	b1	0.07	0.12	0.17
Body Size	D	5 BSC		
	E	5 BSC		
Lead Pitch	e	0.35 BSC		
EP Size	J	3.6	3.7	3.8
	K	3.6	3.7	3.8
Lead Length	L	0.35	0.4	0.45
Package Edge Tolerance	aaa	0.1		
Mold Flatness	bbb	0.1		
Co Planarity	ccc	0.08		
Lead Offset	ddd	0.1		
Exposed Pad Offset	eee	0.1		

END OF DATASHEET

THIS DOCUMENT CONTAINS INFORMATION PROPRIETARY TO FOCALTECH SYSTEMS CO.,LTD., AND MAY NOT BE REPRODUCED, DISCLOSED OR USED IN WHOLE OR PART WITHOUT THE EXPRESS WRITTEN PERMISSION OF FOCALTECH SYSTEMS CO.,LTD.